

SINK FITTINGS

CENTRAL BRASS MFG CO.
2950 East 55th Street, Cleveland, Ohio 44127

C
E
N
T
R
A
L

B
R
A
S
S

M
F
G

C
O
.

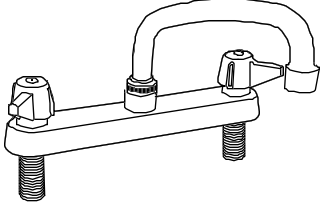
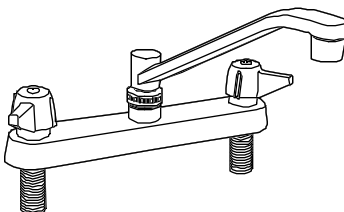
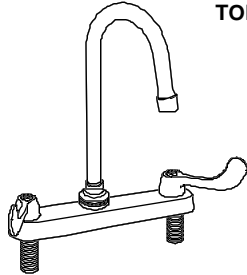
| | Catalog No. | Description | Suggested List Price | Std. Order Qty |
|--|--------------|--|----------------------|----------------|
|  <p>KITCHEN SINK</p> | 0120-A | Cast Brass Top Mount on 8-inch centers with 8-inch tube spout and 2.2 GPM aerator. Replaceable seats. | 71.60 | 12 |
| | 0121-A | Same as above with hose & spray. | 91.10 | 12 |
|  <p>KITCHEN SINK</p> | 0122-A | Cast Brass Top Mount on 8-inch centers with 8-inch brass D-spout and 2.2 GPM aerator. Replaceable seats. | 76.25 | 12 |
| | 0123-A | Same as above with hose & spray. | 95.75 | 12 |
| <p>Suffix No.</p> | 2* | 10-inch Tube Spout with aerator (SU-363-JA) | 8.40 | |
| | 3* | 12-inch Tube Spout with aerator (SU-363-LA) | 9.05 | |
| | 4* | 14-inch Tube Spout with aerator (SU-363-MA) | 9.65 | |
| | 7** | 10-inch Cast Brass Spout with aerator (SU-1974-A) | 38.10 | |
| | 8** | 7 1/4-inch High-Rise Spout with aerator (SU-357-HSA) | 32.00 | |
| | 07** | 8 3/4-inch High-Rise Swivel Spout with aerator (SU-357-WSA) | 29.40 | |
| | GRA** | 4 3/32-inch Rigid Gooseneck Spout with aerator (SU-157-GRA) | .00 | |
| | GSA** | 4 3/32-inch Swivel Gooseneck Spout with aerator (SU-157-GSA) | .00 | |
| | KRA** | 5 1/2-inch Rigid Gooseneck Spout with aerator (SU-157-KRA) | 22.50 | |
| | KSA** | 5 1/2-inch Swivel Gooseneck Spout with aerator (SU-157-KSA) | 22.50 | |
| | ELS | 4-inch Brass Wrist Handles (4147) color-coded indexes | 37.65/pr | |
| | EL | 6-inch Brass Elbow Handles (4149) color-coded indexes | 43.05/pr | |
| | 70 | Acrylic Handles (K-506-1) | 1.80/pr | |
| | 80 | Silver Crown Acrylic Handles (K-504-1) | 7.15/pr | |
| | M | Monel Seats (263-BM) | 7.10/pr | |
| | X | Brass Handles (1143) color-coded indexes & brass locknuts | 29.75/pr | |
| | Q | Quick-Presson Quarter-Turn Stems (SU-354) | .95/pr | |
| <p>Note: For uniform pricing, order the above spouts signified with * or ** as follows: *120, 121, **122, 123</p> | | | | |
| <p>Accessories (Order Separately)</p> | G-1748-88W | Wall Mount Spout Adaptor (includes G-1808-E) | 29.50 | 1 |
| | SU-2775-R-02 | Jointed Spout (7-inch C to C) | 45.65 | 1 |
|  <p>TOP MOUNT</p> | 0122-GSAEL | Cast Brass Top Mount on 8-inch centers with swivel gooseneck spout and 2.2 GPM aerator, 6-inch brass elbow handles(4149) color-coded indexes. Replaceable seats. | 119.30 | 12 |
| | 0122-GSAELS | Same as above with 4-inch brass wrist handles (4147) color-coded indexes. | 113.90 | 12 |

Phone: 216-883-0220 Fax: 216-883-0875 Email: sales @CentralBrass.com

SINK FITTINGS

CENTRAL BRASS MFG CO.
2950 East 55th Street, Cleveland, Ohio 44127

C
E
N
T
R
A
L

B
R
A
S
S

M
F
G

C
O

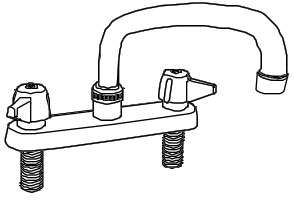
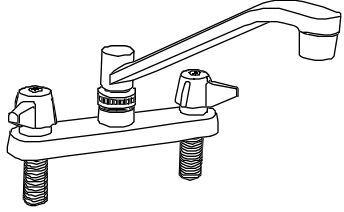
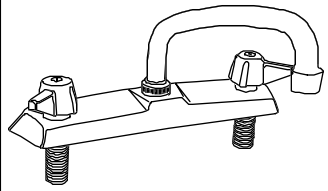
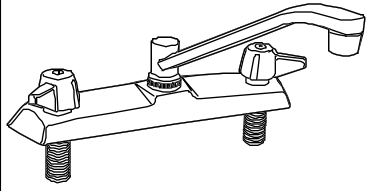
| | Catalog No. | Description | Suggested List Price | Std. Order Qty |
|---|--|---|----------------------|----------------|
|  <p>KITCHEN SINK</p> | 0125-A | Cast Brass Top Mount on 6-inch centers with 8-inch tube spout and 2.2 GPM aerator. Replaceable seats. | 84.30 | 1 |
| | 0126-A | Same as above with hose & spray. | 103.80 | 1 |
|  <p>KITCHEN SINK</p> | 0127-A | Cast Brass Top Mount on 6-inch centers with 8-inch brass D-spout and 2.2 GPM aerator. Replaceable seats. | 88.95 | 1 |
| | 0128-A | Same as above with hose & spray. | 108.45 | 1 |
|  <p>KITCHEN SINK</p> | 0146-A | Shell Top Mount on 8-inch centers with cast brass underbody, 8-inch tube spout and 2.2 GPM aerator. Replaceable seats. | 60.10 | 12 |
| | 0147-A | Same as above with hose & spray. | 79.60 | 12 |
|  <p>KITCHEN SINK</p> | 0148-A | Shell Top Mount on 8-inch centers with Cast Brass underbody, 8-inch brass D-spout and 2.2 GPM aerator. Replaceable seats. | 64.75 | 12 |
| | 0149-A | Same as above with hose & spray. | 84.25 | 12 |
| <p>Suffix No.</p> | 2* | 10-inch Tube Spout with aerator (SU-363-JA) | 8.40 | |
| | 3* | 12-inch Tube Spout with aerator (SU-363-LA) | 9.05 | |
| | 4* | 14-inch Tube Spout with aerator (SU-363-MA) | 9.65 | |
| | 8** | 7 1/4-inch High-Rise Spout with aerator (SU-357-HSA) | 32.00 | |
| | 70 | Acrylic Handles (K-506-1) | 1.80/pr | |
| | <p>Note: For uniform pricing, order the above spouts signified with * or ** as follows: *125, 126, 146, 147 only ** 127, 128, 148, 149, only</p> | | | |
| <p>Phone: 216-883-0220 Fax: 216-883-0875 Email: sales @CentralBrass.com</p> | | | | |

SINK FITTINGS

CENTRAL BRASS MFG CO.
2950 East 55th Street, Cleveland, Ohio 44127

C
E
N
T
R
A
L

B
R
A
S
S

M
F
G

C
O

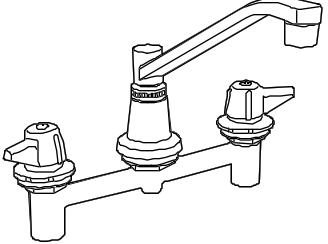
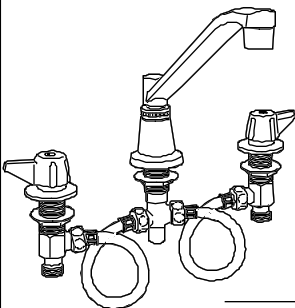
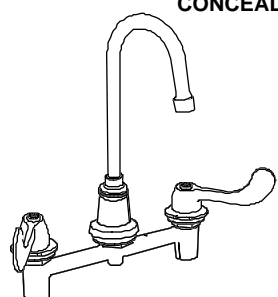
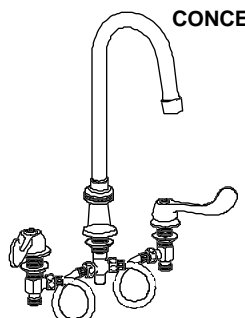
| | Catalog No. | Description | Suggested List Price | Std. Order Qty |
|---|---------------|--|----------------------|----------------|
|  | 0072-A-Q | Concealed Ledge Faucet on 8-inch centers, 8-inch brass D-spout with 2.2 GPM aerator, 1/2-14 NPS female threads on inlets. Quick-Pression quarter-turn stems. Replaceable seats. NOTE: Thickness of sink or countertop cannot exceed <u>1/8"</u> | 95.50 | 1 |
| | 0073-A-Q | Same as above with hose & spray. | 116.50 | 1 |
|  | 1172-A-Q | Concealed ledge faucet with flexible hose connections, adjustable from 6-inches to 24-inches, 8-inch brass D-spout with 2.2 GPM aerator, 1/2-14 NPS male threads on inlets. Quick-Pression quarter-turn stems. Replaceable seats. NOTE: Thickness of sink or countertop cannot exceed <u>1 3/8"</u> | 126.00 | 1 |
| | 1173-A-Q | Same as above with hose & spray. | 158.10 | 1 |
| Suffix No. | 7 | 10-inch Cast Spout with aerator (SU-1974-A) | 38.10 | |
| | 8 | 7 1/4-inch High-Rise Spout with aerator (SU-357-HSA) | 32.00 | |
| | 07 | 8 3/4-inch High-Rise Swivel Spout with aerator (SU-357-WSA) | 29.40 | |
| | GRA | 4 3/32-inch Rigid Gooseneck Spout with aerator (SU-157-GRA) | .00 | |
| | GSA | 4 3/32-inch Swivel Gooseneck Spout with aerator (SU-157-GSA) | .00 | |
| | KRA | 5 1/2-inch Rigid Gooseneck Spout with aerator (SU-157-KRA) | 22.50 | |
| | KSA | 5 1/2-inch Swivel Gooseneck Spout with aerator (SU-157-KSA) | 22.50 | |
| | ELS | 4-inch Brass Wrist Handles (4147) color-coded indexes | 37.65/pr | |
| | EL | 6-inch Brass Elbow Handles (4149) color-coded indexes | 43.05/pr | |
| | X | Brass Handles (1143) color-coded indexes & brass locknuts | 29.75/pr | |
|  | 0072-GSAEL-Q | Cast Brass Concealed Ledge Fitting on 8-inch centers, 1/2-14 NPS female threads, swivel gooseneck spout with 2.2 GPM aerator and 6-inch brass elbow handles (4149) color-coded indexes. Quick-Pression Quarter-Turn stems. Replaceable seats. NOTE: Thickness of sink or countertop cannot exceed <u>1/8"</u> | 138.55 | 1 |
| | 0072-GSAELS-Q | Same as above but with 4-inch brass wrist handles (4147) color-coded indexes | 133.15 | 1 |
|  | 1172-GSAEL-Q | Cast Brass wide spread with flexible hose connections adjustable from 6-inches to 24-inches, swivel gooseneck spout with 2.2 GPM aerator and 6-inch brass elbow handles (4149) color-coded indexes. Quick-Pression quarter-turn stems. Replaceable seats. NOTE: Thickness of sink or countertop cannot exceed <u>1 3/8"</u> | 169.05 | 1 |
| | 1172-GSAELS-Q | Same as above but with 4-inch brass wrist handles (4147) color-coded indexes. | 163.65 | 1 |

Phone: 216-883-0220 Fax: 216-883-0875 Email: sales @CentralBrass.com

SINK FITTINGS

CENTRAL BRASS MFG CO.
2950 East 55th Street, Cleveland, Ohio 44127

C
E
N
T
R
A
L

B
R
A
S
S

M
F
G

C
O

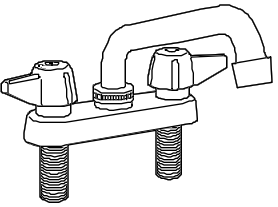
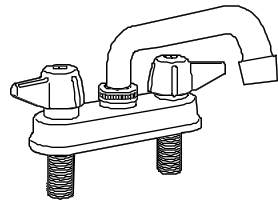
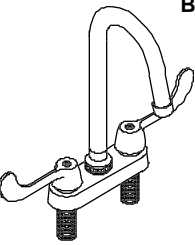
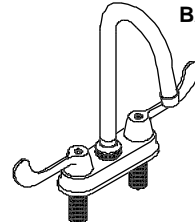
| | Catalog No. | Description | Suggested List Price | Std. Order Qty |
|---|---|--|--|----------------|
|  | 0084-A | Cast Brass Bar/Laundry Faucet on 4-inch centers, 6-inch tube spout with 2.2 GPM aerator and polished chrome finish. Replaceable seats. | 63.50 | 12 |
| | | | ♿ | |
|  | 0094-A | Shell Type Bar/Laundry Faucet on 4-inch centers, with cast brass underbody, 6-inch tube spout with 2.2 GPM aerator and polished chrome finish. Replaceable seats. | 54.60 | 12 |
| | | | ♿ | |
| Suffix No. | 1 | 8-inch Tube Spout with aerator (SU-363-RA) | .90 | |
| | 2 | 10-inch Tube Spout with aerator (SU-363-JA) | 7.85 | |
| | 3 | 12-inch Tube Spout with aerator (SU-363-LA) | 8.50 | |
| | 4 | 14-inch Tube Spout with aerator (SU-363-MA) | 9.10 | |
| | 6 | 8-inch Brass D-Spout with aerator (SU-365-CA) | 10.10 | |
| | 8 | 7 1/4-inch High-Rise Spout with aerator (SU-357-HSA) | 39.00 | |
| | 06 | 5-inch Brass D-Spout with aerator (SU-364-A) | 9.90 | |
| | GRA | 4 3/32-inch Rigid Gooseneck Spout with aerator (SU-157-GRA) | 7.55 | |
| | GSA | 4 3/32-inch Swivel Gooseneck Spout with aerator (SU-157-GSA) | 5.30 | |
| | KRA | 5 1/2-inch Rigid Gooseneck Spout with aerator (SU-157-KRA) | 29.00 | |
| | KSA | 5 1/2-inch Swivel Gooseneck Spout with aerator (SU-157-KSA) | 29.00 | |
| | H | Hose Adaptor (PF-784-C) | .00 | |
| | ELS | 4-inch Brass Wrist Handles (4147) color- coded indexes | 37.65/pr | |
| | EL | 6-inch Brass Elbow Handles (4149) color- coded indexes | 43.05/pr | |
| | X | Brass Handles (1143) color- coded indexes & brass locknuts | 29.75/pr | |
| | Q | Quick-Presson Quarter-Turn Stems (SU-354) | .95/pr | |
| | Accessories (Order Separately) | G-1748-88W | Wall Mount Spout Adaptor (includes G-1808-E) | 29.50 |
| SU-2775-R-02 | | Jointed Spout (7-inch C to C) | 46.65 | 1 |
|  | 0084-GSAEL | Cast Brass Top Mount on 4-inch centers with swivel gooseneck spout and 2.2 GPM aerator and 6-inch brass elbow handles (4149) color-coded indexes. | 111.85 | 12 |
| | 0084-GSAELS | Same as above with 4-inch brass wrist handles (4147) color-coded indexes. | 106.45 | 12 |
|  | 0094-GSAEL | Shell Type Top Mount on 4-inch centers with swivel gooseneck spout and 2.2 GPM aerator and 6-inch brass elbow handles (4149) color-coded indexes. Replaceable seats. | 102.95 | 12 |
| | 0094-GSAELS | Same as above but with 4-inch brass wrist handles (4147) color-coded indexes. | 97.55 | 12 |

Phone: 216-883-0220 Fax: 216-883-0875 Email: sales @CentralBrass.com

SINK FITTINGS

CENTRAL BRASS MFG CO.
2950 East 55th Street, Cleveland, Ohio 44127

C
E
N
T
R
A
L

B
R
A
S
S

M
F
G

C
O

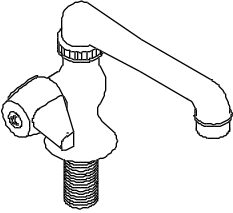
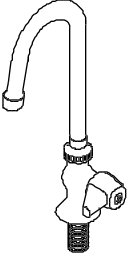
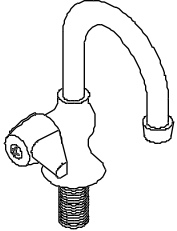
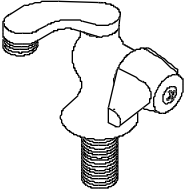
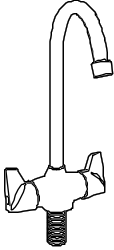
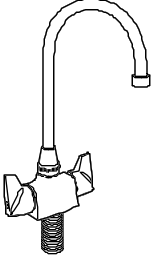
| | Catalog No. | Description | Suggested List Price | Std. Order Qty |
|---|-------------|--|----------------------|----------------|
|  <p>BAR FAUCET</p> | 0280-A | Cast Brass Single Bar Faucet with 1/2-14 NPS male shank x 1 7/8-inches long and 5-inch cast brass swing spout with 2.2 GPM aerator. Replaceable seat. (Specify Hot or Cold). | 69.85 | 6 |
|  <p>BAR FAUCET</p> | 0280-GSAC | Cast Brass Single Bar Faucet with 1/2-14 NPS male shank x 1 7/8-inches long and swivel gooseneck spout with 2.2 GPM aerator. Replaceable seat. (Cold only). | 60.20 | 6 |
|  <p>BAR FAUCET</p> | 0281-A | Cast Brass Single Bar Faucet with 1/2-14 NPS male shank x 1 7/8-inches long and rigid gooseneck spout with 2.2 GPM aerator. Replaceable seat. (Specify Hot or Cold). | 64.70 | 6 |
|  <p>DISHWASHER FAUCET</p> | 0282 | Portable Dishwasher Faucet with 1/2-14 NPS male shank x 1 7/8-inches long and rigid spout. Replaceable seat. (Hot only). | 64.60 | 1 |
|  <p>BAR FAUCET</p> | 0284-A-Q | Cast Brass Contemporary-Styled Bar/Pantry Faucet with Quick-Pression quarter-turn stems and rigid gooseneck spout with 2.2 GPM aerator. Replaceable seats. | 137.25 | 1 |
|  <p>BAR FAUCET</p> | 0285-A-Q | Cast Brass Contemporary-Styled Bar/Pantry Faucet with Quick-Pression quarter-turn stems and swivel gooseneck spout with 2.2 GPM aerator. Replaceable seats. | 149.75 | 1 |

Phone: 216-883-0220 Fax: 216-883-0875 Email: sales @CentralBrass.com

SINK FITTINGS

CENTRAL BRASS MFG CO.
2950 East 55th Street, Cleveland, Ohio 44127

C
E
N
T
R
A
L

B
R
A
S
S

M
F
G

C
O

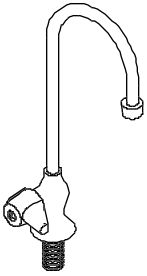
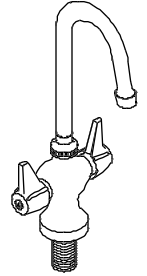
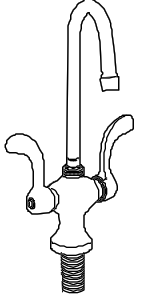
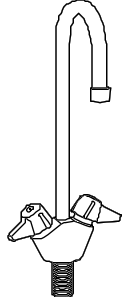
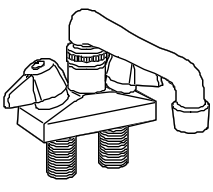
| | Catalog No. | Description | Suggested List Price | Std. Order Qty |
|--|---------------|--|----------------------|----------------|
|  <p>BAR FAUCET</p> | 0286-A | Cast Brass Single Bar Faucet with 1/2-14 NPS male shank x 1 7/8-inches long and rigid gooseneck spout, with 2.2 GPM aerator. Replaceable seat. (Specify Hot or Cold). | 68.75 | 6 |
|  <p>BAR FAUCET</p> | 0287-GSA | Cast Brass Double Bar/Pantry Faucet, 1 1/16-14 NPS male shank, copper supply tubes and swivel gooseneck spout with 2.2 GPM aerator. Replaceable seats. | 115.75 | 1 |
|  <p>BAR FAUCET</p> | 0287-GSAELS-Q | Cast Brass Double Bar/Pantry Faucet with Quick-Pressure quarter-turn stems, 1 1/16-14 NPS male shank, copper supply tubes and swivel gooseneck spout with 2.2 GPM aerator and 4-inch brass wrist handles. Replaceable seats. | 154.35 | 1 |
|  <p>BAR FAUCET</p> | 0289-A | Cast Brass Double Bar Faucet, 1 1/16-14 NS-2 male shank, copper supply tubes and rigid gooseneck spout with 2.2 GPM aerator. Replaceable seats. | 105.75 | 1 |
|  <p>BAR FAUCET</p> | 0085-A | Cast Brass Bar Faucet with 5-inch cast brass spout, with 2.2 GPM aerator, 1 3/4-inch centers, 3/8-18 NPT female threads, and polished chrome finish. Replaceable seats. | 117.00 | 1 |
| <p>Accessories (Order Separately)</p> | G-1748-88W | Wall Mount Spout Adaptor (includes G-1808-E) (0085 ONLY) | 29.50 | 1 |

Phone: 216-883-0220 Fax: 216-883-0875 Email: sales @CentralBrass.com

SINK FITTINGS

CENTRAL BRASS MFG CO.
2950 East 55th Street, Cleveland, Ohio 44127

C
E
N
T
R
A
L

B
R
A
S
S

M
F
G

C
O

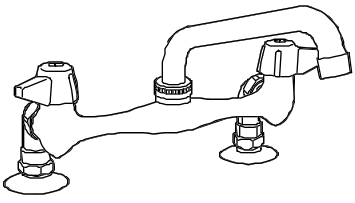
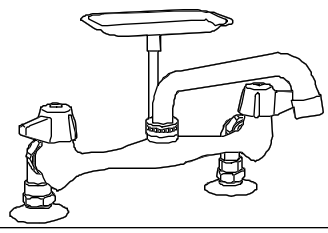
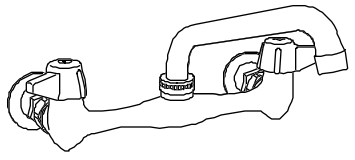
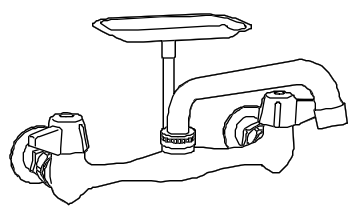
| | Catalog No. | Description | Suggested List Price | Std. Order Qty |
|--|-------------|--|----------------------|----------------|
|  | 0045-A | Ledge Sink Fitting with 1/2-14 NPS female elbow inlet on 8-inch centers, 6-inch tube spout with 2.2 GPM aerator, replaceable seats and polished chrome finish. | 178.50 | 1 |
| | | | ♿ | |
|  | 0046-A | Ledge Sink Fitting with 1/2-14 NPS female elbow inlets on 8-inch centers, 6-inch tube spout with 2.2 GPM aerator, replaceable seats, brass soap dish and polished chrome finish. | 183.10 | 1 |
| | | | ♿ | |
|  | 0047-TA | Wall Mount with 1/2-14 NPT male shank with adjustable flange and 6-inch tube spout with 2.2 GPM aerator, replaceable seats and polished chrome finish. | 94.65 | 12 |
| | | | ♿ | |
| | 0047-UA | Wall Mount with 1/2-14 NPS female inlets and 6-inch tube spout with 2.2 GPM aerator, replaceable seats and polished chrome finish. | 94.65 | 12 |
| | | | | |
|  | 0048-TA | Wall Mount with 1/2-14 NPT male shank with adjustable flange, 6-inch tube spout with 2.2 GPM aerator, replaceable seats, brass soap dish and polished chrome finish. | 99.25 | 12 |
| | | | ♿ | |
| | 0048-UA | Wall Mount with 1/2-14 NPS female inlets, 6-inch tube spout with 2.2 GPM aerator, replaceable seats, brass soap dish and polished chrome finish. | 99.25 | 12 |
| | | | ♿ | |
| | | SPOUT OPTIONS | | |
| Suffix No. | 1 | 8-inch Tube Spout with aerator (SU-363-RA) | .90 | |
| | 2 | 10-inch Tube Spout with aerator (SU-363-JA) | 7.85 | |
| | 3 | 12-inch Tube Spout with aerator (SU-363-LA) | 8.50 | |
| | 4 | 14-inch Tube Spout with aerator (SU-363-MA) | 9.10 | |
| | 6 | 8-inch Brass D-Spout with aerator (SU-365-CA) | 10.10 | |
| | 7 | 10-inch Cast Brass Spout with aerator (SU-1974-A) | 44.60 | |
| | 9 | 5-inch Cast Brass Spout with aerator (SU-2923-A) | 19.40 | |
| | GRA* | 4 3/32-inch Rigid Gooseneck Spout with aerator (SU-157-GRA) | 7.55 | |
| | GSA* | 4 3/32-inch Swivel Gooseneck Spout with aerator (SU-157-GSA) | 5.30 | |
| | KRA* | 5 1/2-inch Rigid Gooseneck Spout with aerator (SU-157-KRA) | 29.00 | |
| | KSA* | 5 1/2-inch Swivel Gooseneck Spout with aerator (SU-157-KSA) | 29.00 | |
| | H | Hose Adaptor (PF-784-C) | 2.10 | |
| <p>Note: The above spouts signified with * are only available on the 0045 and 0047 series</p> <p>(Suffixes continued on next page)</p> | | | | |
| <p>Phone: 216-883-0220 Fax: 216-883-0875 Email: sales @CentralBrass.com</p> | | | | |

SINK FITTINGS

CENTRAL BRASS MFG CO.
2950 East 55th Street, Cleveland, Ohio 44127

C
E
N
T
R
A
L

B
R
A
S
S

M
F
G

C
O

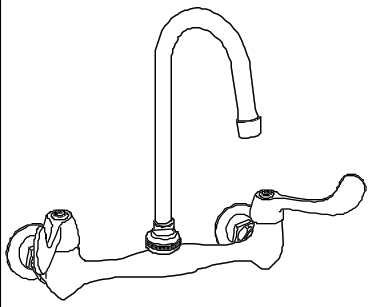
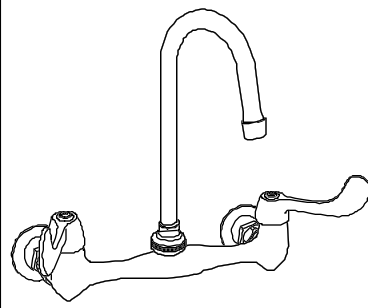
| | Catalog No. | Description | Suggested List Price | Std. Order Qty | |
|--|---|--|---|----------------|---|
| (Suffixes continued from previous page) | | | | | |
| Suffix No. | ELS | 4-inch Brass Wrist Handles (4147) color- coded indexes | 37.65/pr | | |
| | EL | 6-inch Brass Elbow Handles (4149) color- coded indexes | 43.05/pr | | |
| | X | Brass Lever Handles (1143) color-coded indexes & brass locknuts | 29.75/pr | | |
| | M | Monel Seats (263-BM) | 7.10/pr | | |
| | S | 1/2-14 NPS female inlet flanges adjustable from 6 1/2-inch to 9 1/2-inch centers (SU-2806) | 13.50/pr | | |
| | Q | Quick-Pression Quarter-Turn Stems (SU-354) | .95/pr | | |
| Accessories (Order Separately) | SU-2775-R-02 | Jointed Spout (7-inch C to C) | 46.65 | 1 | |
| WALL MOUNT  | 0047-TGSAEL | Cast Brass Wall Mount Faucet with 1/2-14 NPT male shank on 8-inch centers, swivel gooseneck spout with 2.2 GPM aerator, 6-inch brass elbow handles (4149) color-coded indexes. Replaceable seats and polished chrome finish. | 143.00 | 12 | |
| | 0047-TGSAELS | Same as above but with 4-inch brass wrist handles (4147) color-coded indexes. | 137.60 | 12 | |
| WALL MOUNT  | 0047-UGSAEL | Cast Brass Wall Mount Faucet 1/2-14 NPS female inlets on 8-inch centers, swivel gooseneck spout with 2.2 GPM aerator, 6-inch brass elbow handles (4149) color-coded indexes. Replaceable seats and polished chrome finish. | 143.00 | 12 | |
| | 0047-UGSAELS | Same as above but with 4-inch brass wrist handles (4147) color-coded indexes. | 137.60 | 12 | |
| Suffix No. | GRA | 4 3/32-inch Rigid Gooseneck Spout with aerator (SU-157-GRA) | 2.25 | | |
| | M | Monel Seats (263-BM) | 7.10/pr | | |
| | S | 1/2- 14 NPS female inlet flanges adjustable from 6 1/2-inch to 9 1/2-inch centers (SU-2806) | 13.50/pr | | |
| | Q | Quick-Pression Quarter-Turn Stems (SU-354) | .95/pr | | |
| | Accessories (Order Separately) | G-30-LV | Vandal-Resistant Flow Restrictor -Limits flow to .5 GPM | 8.50 | 1 |
| | | 30-LFF | Laminar Flow Streamformer 55/64-inch Female | 4.10 | 1 |
| | | 30-LFM | Laminar Flow Streamformer 15/16-inch Male | 4.10 | 1 |
| | | 166-UB | Adapter - from 55/64-inch Female to 1 3/16-inch Male | 1.70 | 1 |

Phone: 216-883-0220 Fax: 216-883-0875 Email: sales @CentralBrass.com

SINK FITTINGS

CENTRAL BRASS MFG CO.
2950 East 55th Street, Cleveland, Ohio 44127

C
E
N
T
R
A
L

B
R
A
S
S

M
F
G

C
O

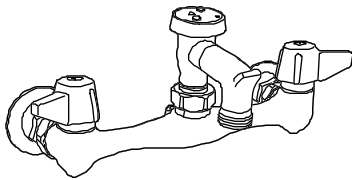
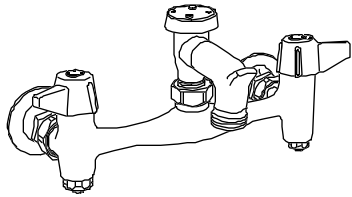
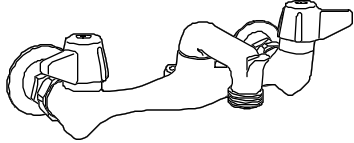
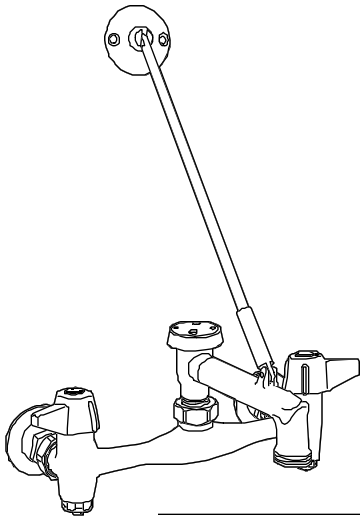
| | Catalog No. | Description | Suggested List Price | Std. Order Qty |
|---|-------------|---|----------------------|----------------|
| SERVICE SINK FAUCET  | 0050-URC | Heavy Duty Cast Brass Assembly with 1/2-NPS female inlet flanges on 8-inch centers, vacuum breaker with 2 1/2-inch rigid cast spout with 3/4-inch hose thread on outlet and pail hook; rough chrome finish. Replaceable seats. | 134.75 | 1 |
| SERVICE SINK FAUCET  | 0050-URC-QI | Same as 0050-URC but with Quick-Pression quarter-turn stems and screwdriver stops built into faucet body. Replaceable seats. | 154.50 | 1 |
| SERVICE SINK FAUCET  | 0051-URC | Heavy Duty Cast Brass Assembly with 1/2 - 14 NPS female inlet flanges on 8-inch centers, rigid spout with pail hook and 3/4-inch hose thread on outlet. Rough chrome finish. Replaceable seats. | 106.50 | 1 |
| SERVICE SINK FAUCET  | 0054-U-QI | Heavy Duty Cast Brass Assembly with rigid spout with vacuum breaker, 3/4-inch hose thread on outlet, pail hook and top brace to wall w/ flange; distance from finished wall to outlet adjustable for 9-inch to 9 1/2-inch, 1/2-14 NPS female inlet flanges, on 8-inch centers, screwdriver stops built into faucet body, heavy-duty Quick-Pression quarter-turn stems and replaceable seats; canopy lever handles with color-coded indexes; polished chrome finish. | 229.75 | 1 |
| | 0054-URC-QI | Same as above but with rough chrome finish. | 183.25 | 1 |
| | 0054-U-Q | Same as 0054-U-QI but less screwdriver stops. | 201.25 | 1 |
| | 0054-URC-Q | Same as above with rough chrome finish. | 159.75 | 1 |
| Suffix No. | ELS | 4-inch Brass Wrist Handles (4147) color-coded indexes | 37.65/pr | |
| | EL | 6-inch Brass Elbow Handles (4149) color-coded indexes | 43.05/pr | |
| | X | Brass Lever Handles (1143) color-coded indexes | 29.75/pr | |
| | M | Monel Seats (263-BM) | 7.10/pr | |
| | S | 1/2-14 NPS female inlet flanges adjustable from 6 1/2-inch to 9 1/2-inch centers (SU-2806) | 13.50/pr | |
| | T | 1/2-14 NPT male inlet shank (SU-2846) with adjustable flange. | .00/pr | |
| | YRC | 1/2-14 NPS female inlet flanges with integral stops adjustable from 3-inch to 13-inch centers (SU-2841-ARC). Rough chrome finish. | 40.75/pr | |

Phone: 216-883-0220 Fax: 216-883-0875 Email: sales @CentralBrass.com

SINK FITTINGS

CENTRAL BRASS MFG CO.
2950 East 55th Street, Cleveland, Ohio 44127

C
E
N
T
R
A
L

B
R
A
S
S

M
F
G

C
O

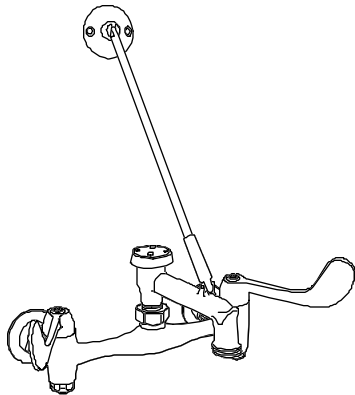
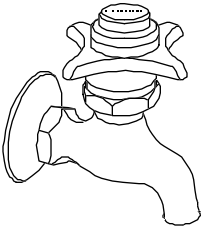
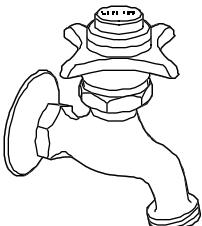
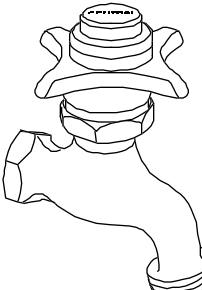
| | Catalog No. | Description | Suggested List Price | Std. Order Qty | |
|---|---------------|--|----------------------|----------------|--|
|  | 0054-UQL-QI | Heavy Duty Cast Brass Assembly with rigid spout with vacuum breaker, 3/4-inch hose thread on outlet, pail hook and top brace to wall with flange; distance from finished wall to outlet adjustable for 9-inch to 9 1/2-inch 1/2 - 14 NPS female inlet flanges, on 8-inch centers, heavy-duty Quick-Pression quarter-turn stems and replaceable seats; screwdriver stops built into faucet body; 6-inch brass elbow handles with color-coded indexes; polished chrome finish. | 272.80 | 1 | |
| | 0054-UELS-QI | Same as above but with 4-inch brass wrist handles with color-coded indexes | 267.40 | 1 | |
| | Suffix No. | M | Monel Seats (263-BM) | 7.10/pr | |
| | S | 1/2- 14 NPS female inlet flanges adjustable from 6 1/2-inch to 9 1/2-inch centers (SU-2806) | 13.50/pr | | |
| | T | 1/2- 14 NPT male inlet shank (SU-2846) with adjustable flange. | .00/pr | | |
|  | 0033-1/2PV-02 | Self-Closing Wall Mount - 1/2-14 NPS female threads on inlet, with solid flange, plain end on outlet, 4-arm handle and polished chrome finish. Replaceable seat. (Specify Hot, Cold or Plain) | 85.50 | 1 | |
|  | 0033-H1/2 | Self-Closing Wall Mount - 1/2-14 NPS female threads on inlet, with solid flange, 3/4-inch hose thread on outlet, 4-arm handle and rough chrome finish. Replaceable seat. (Specify Hot, Cold or Plain) | 67.25 | 6 | |
|  | 0031-H1/2 | Self-Closing Wall Mount - 1/2-14 NPT male inlet shank, 3/4-inch hose thread on outlet, 4-arm handle and rough chrome finish. Replaceable seat. (Specify Hot, Cold or Plain) | 63.75 | 6 | |
| <p>Phone: 216-883-0220 Fax: 216-883-0875 Email: sales @CentralBrass.com</p> | | | | | |

SINK FITTINGS

CENTRAL BRASS MFG CO.
2950 East 55th Street, Cleveland, Ohio 44127

C
E
N
T
R
A
L

B
R
A
S
S

M
F
G

C
O

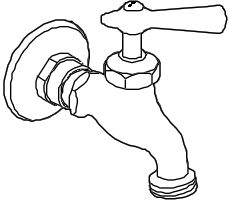
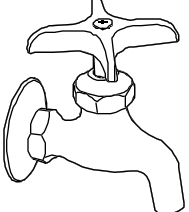
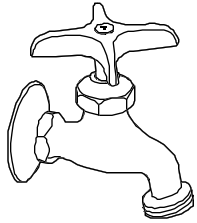
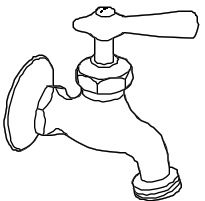
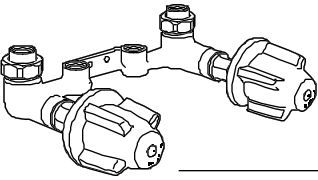
| | Catalog No. | Description | Suggested List Price | Std. Order Qty |
|---|-------------|--|----------------------|----------------|
| WALL MOUNT  | 0005-H1/2 | Cast Brass Wall Mount, 1/2-NPS female threads, with adjustable flange, hose end, 4-arm handle and polished chrome finish. Replaceable seat. (Specify Hot, Cold or Plain). | 50.55 | 6 |
| WALL MOUNT  | 0006-H1/2 | Cast Brass Wall Mount, 1/2-14 NPT male shank, with adjustable flange, hose end and rough chrome finish. Replaceable seat. (Specify Hot or Cold). | 35.10 | 6 |
| WALL MOUNT  | 0007-1/2 | Cast Brass Body with solid flange, 1/2-14 NPS female threads, plain end, 4-arm handle and polished chrome finish; plain handle only. Replaceable seat. | 43.00 | 6 |
| WALL MOUNT  | 0007-H1/2 | Same as 0007-1/2 with hose end; plain handle only. Replaceable seat. | 44.95 | 6 |
| WALL MOUNT  | 0009-H1/2 | Cast Brass Body with solid flange, 1/2-14 NPS female threads, hose end and rough chrome finish. Replaceable seat. (Specify Hot or Cold). | 30.85 | 6 |
| WASH MACHINE FILLER  | 0455 | Cast Brass Wash Machine Filler - with 1/2-14 NPSF (Dryseal) female union inlet, and 1/2 - 14 NPS female outlet, 8-inch centers and chrome plated handles and escutcheons. Replaceable seats. | 86.10 | 1 |
| Suffix No. | C | Copper Sweat Union (1875-C) | .00 | |

Phone: 216-883-0220 Fax: 216-883-0875 Email: sales @CentralBrass.com

SINK FITTINGS

CENTRAL BRASS MFG CO.
2950 East 55th Street, Cleveland, Ohio 44127

C
E
N
T
R
A
L

B
R
A
S
S

M
F
G

C
O

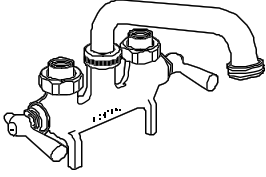
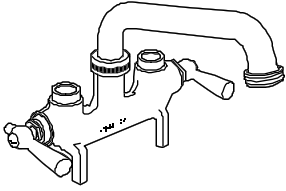
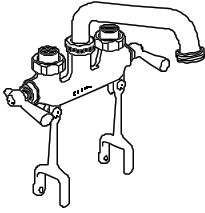
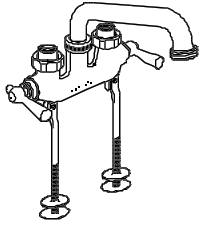
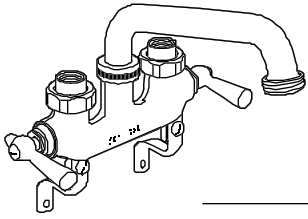
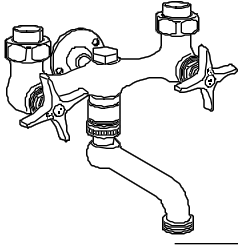
| | Catalog No. | Description | Suggested List Price | Std. Order Qty |
|--|-------------|---|----------------------|----------------|
|  <p>LAUNDRY FAUCET</p> | 0465 | Cast Brass Laundry Faucet on 3 1/2-inch centers, 1/2-14 NPSF (Dryseal) female coupling union connections, 6-inch tube spout with hose end, straddle legs and rough brass finish. | 45.30 | 12 |
|  <p>LAUNDRY FAUCET</p> | 0466 | Cast Brass Laundry Faucet on 3 1/2-inch centers, direct sweat connections, 6-inch tube spout with hose end, straddle legs and rough brass finish. | 40.75 | 12 |
|  <p>LAUNDRY FAUCET</p> | 0468 | Cast Brass Laundry Faucet on 3 1/2-inch centers, 1/2-14 NPSF (Dryseal) female coupling union connections, 6-inch tube spout with hose end, extended straddle legs and rough brass finish. | 58.05 | 6 |
|  <p>LAUNDRY FAUCET</p> | 0469 | Same as above with extended hole mount legs. | 62.70 | 6 |
|  <p>LAUNDRY FAUCET</p> | 0470 | Same as above but with offset legs for wallmount. | 55.05 | 6 |
| Suffix No. | 5 | 6-inch Cast Spout with Hose End (SU-2929-01) rough brass | 3.10 | |
| | C | Copper Sweat Union (1875-C) (Not available on 466) | .00 | |
|  <p>LAUNDRY FAUCET</p> | 0471-RC | Laundry Sink Faucet on 6-inch centers. Rough chrome finish only. Replaceable seats. | 134.10 | 1 |
| Suffix No. | C | Copper Sweat Union (1875-C) | .00 | |

Phone: 216-883-0220 Fax: 216-883-0875 Email: sales @CentralBrass.com